

Date Project Part #

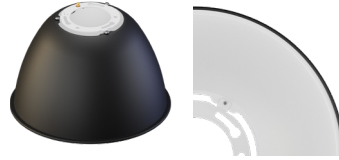

Gray Exterior/White Interior

Standard Finish Options



Black Exterior/White Interior

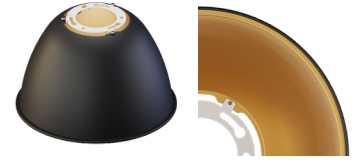

Black Exterior/Gold Interior

* Inquire for custom finish

Features

The optional reflector is available to create a traditional high-bay aesthetic. However, these reflectors are not needed and its installation does not substantially alter the light distribution. The Filamento lamp has integral optics that create a cutoff at 50°, eliminating glare so an external reflector is not required.

- Solid aluminum reflector
- Reflectors are vented to allow for airflow
- Compatible with all ADP mounting bases
- Compatible with all VA6 mogul base lamps
- Easy to install - Simply twist and lock assembly to ADP mounting bases, no tools required
- Optional diffuser, drop lens, wireguard accessories
- ADP mounting bases are sold separately
- See website for Installation Guide

Mechanical

- 0.36 kg / 0.8 lb
- Solid aluminum body
- Inquire for custom colors

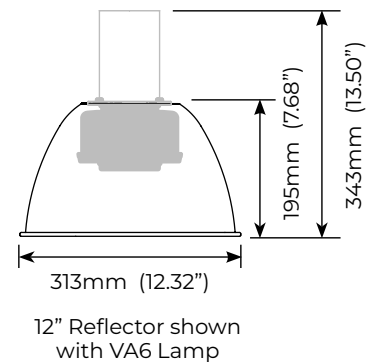

Compatible Accessories

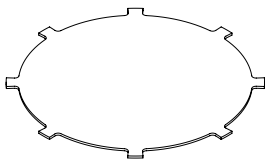

12" UGR Diffuser
ACC-012-UGR-000-FL

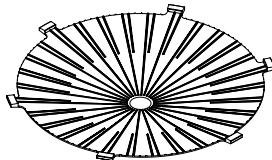

12" Conical Lens
ACC-012-CNL-000-FL

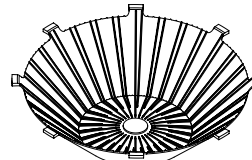

12" Drop Lens
ACC-012-DRL-000-FL

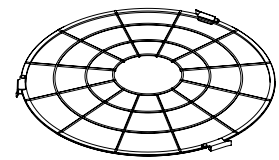

12" Wireguard Black
ACC-012-WBK-000-FL

Ordering Information

Description	Part Code	Part #
Aluminum Bell 12" Reflector - Gray Exterior/White Interior	03921	RFL-AB12-GR2WH2
Aluminum Bell 12" Reflector - Black Exterior/Gold Interior	03924	RFL-AB12-BK2GD2
Aluminum Bell 12" Reflector - Black Exterior/White Interior	03927	RFL-AB12-BK2WH2

1. Inquire for custom color combinations
2. [See limited warranty for details](#)
3. Specifications subject to change without notice

4. Not intended for use in environments containing airborne corrosive agents such as chemicals, solvents, or cutting fluids